

Bestell-Nr.: 0301107000

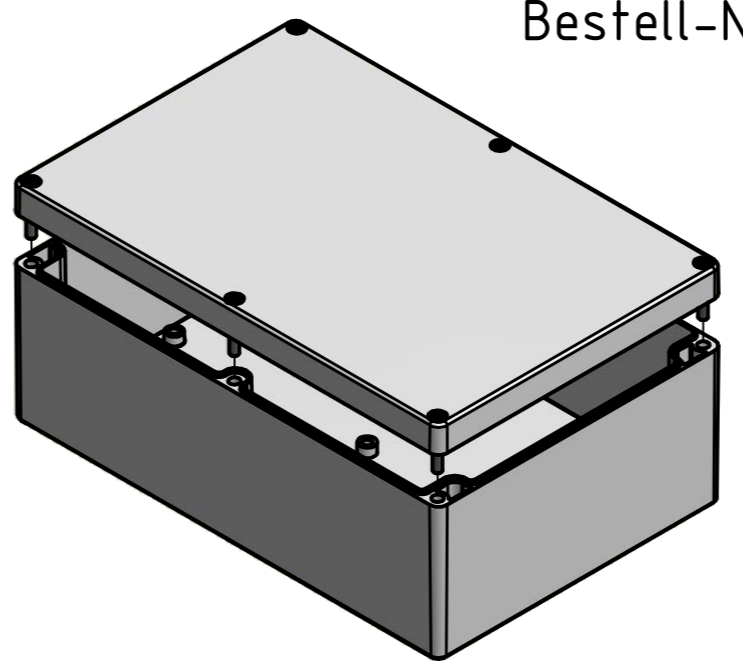

* = Durch Formkonizität bedingte Verjüngung
 Dimensions may deviate at the bottom due to conical form (mold deforming)

	(Zul. Abw.) ISO 2768 - K DIN 16742 - TG4	(Oberfläche)	Maßstab: 1:1 (1:3)	Gewicht: -
	DIN-A2		Werkstoff: Polycarbonat	
	Datum	Name	Benennung:	
	Bearb. 03.12.2015	R. Rentz	MBM 241690	
	Gepr. 03.12.2015	E. Schellenb.	Zeichnungsnummer:	
	Norm		0301107000-MBM_241690	
MULTI-BOX GmbH Walltücker Bahndamm 7 D-32278 Kirch Lengern www.multi-box.com			(Ers. f.):	(Ers. d.):
Zust.	Änderung	Datum	Name (Urspr.)	Blatt 1 Bl. 1