

Bestell-Nr.: 0301101000

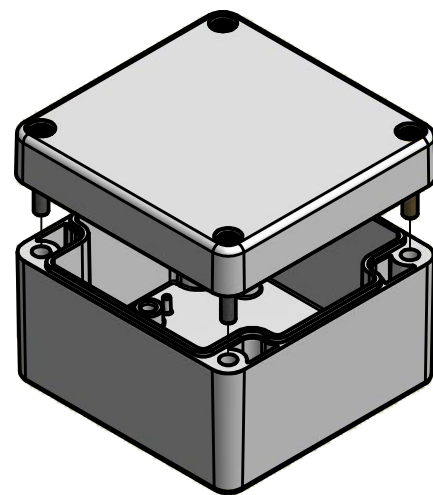

\* = Durch Formkonizität bedingte Verjüngung  
 Dimensions may deviate at the bottom due to conical form (mold deforming)

<b>MULTI-BOX</b> THE BOX COMPANY	(Zul.Abw.) ISO 2768 - K DIN 16742 TG4	(Oberfläche)	Maßstab: 1:1	Gewicht: -	
	DIN-A3		Werkstoff: Polycarbonat		
	Datum	Name	Benennung:		
	Bearb. 16.11.2015	R.Rentz	<b>MBM 080805</b>		
	Gepr. 16.11.2015	E.Schellenb.			
	Norm		Zeichnungsnummer:		
	MULTI-BOX GmbH Wallücker Bahndamm 7 D-32278 Kirchlengern www.multi-box.com		0301101000-MBM_080805		
Zust.	Änderung	Datum	Name	(Ers. f.):	(Ers. d.):

Blatt  
1  
Bl. 1